

NO	DESCRIPTION	MAT'L	Q'TY	WT(kg)	REMARKS

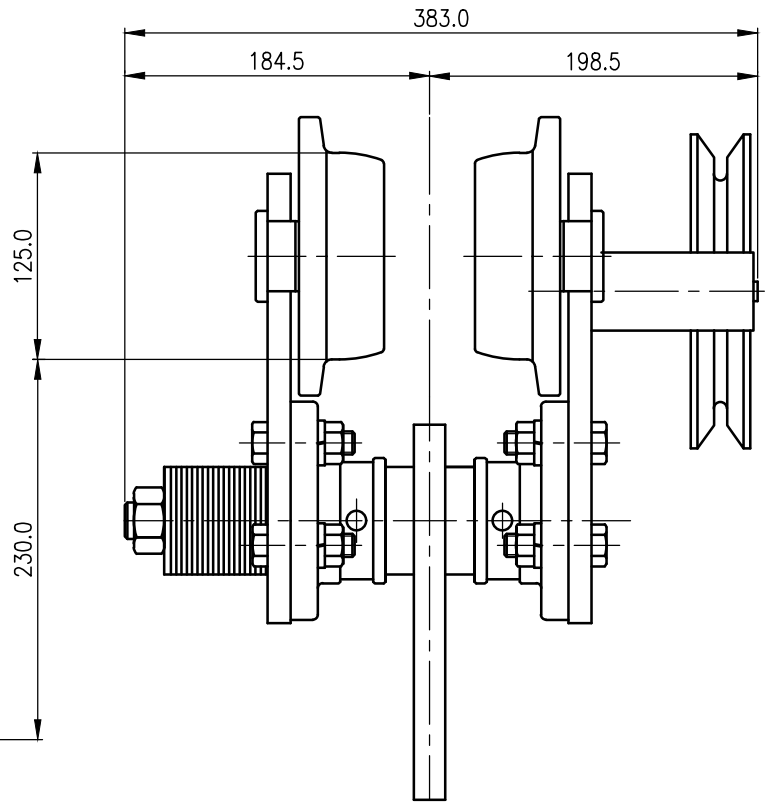
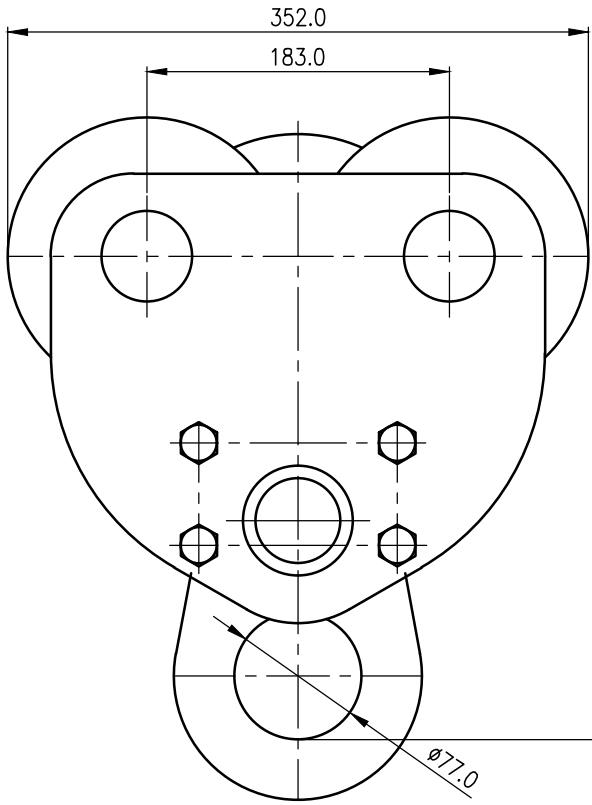

TITLE				5TON GEAR TROLLEY		PROJECTION	
WORK NO				WORK NAME			
				SCALE		Q'TY	
				1/2		1	
DRAWN	CHECKED	REVIEWED	APPROVED	DRAWING NO			
YOO.M.R	-	LEE. H.J	Y. K	DSGT050001			
2012.06.25	-	2012.06.21	2012.09.04				
DAESAN INoTEC INC							

REV.NO	DATE	REVISION DESCRIPTION	DRAWN	CHECKED	APPROVED