

NO	DESCRIPTION	Q' TY	WT (kg)	REMARKS	NO	DESCRIPTION	Q' TY	WT (kg)	REMARKS	NO	DESCRIPTION	Q' TY	WT (kg)	REMARKS
001	COTTER PIN	1		∅3x20	012	PINION SHAFT	1			022	CENTER PLATE	1		
002	PLAIN WASHER	1		M12	013	U-NUT	1		M10	023	HEX NUT S/W	8		M14
003	HAND WHEEL	1			014	PLAIN ROLLER	2			024	HEX BOLT	8		M14x50
004	GUIDE PLATE	1			A15	PLAIN SIDE PLATE ASS'Y	1			025	ADJUST WASHER	16		
006	WRENCH BOLT S/W	2		M6x15	016	NAME PLATE	1			026	SIDE WASHER	1		
A07	GEAR SIDE PLATE ASS'Y	1			018	FIX BOLT	1		M10x90	027	U NUT	1		M22
008	BALL BEARING	4		6206ZZ	019	BRACKET	2			028	HAND CHAIN	1		
009	GEAR ROLLER	2			020	STAY	1			029	PINION NUT	1		
010	SNAP RING	4		S-30	021	RING	2			036	CONNECTOR ASS'Y	1		OPTION

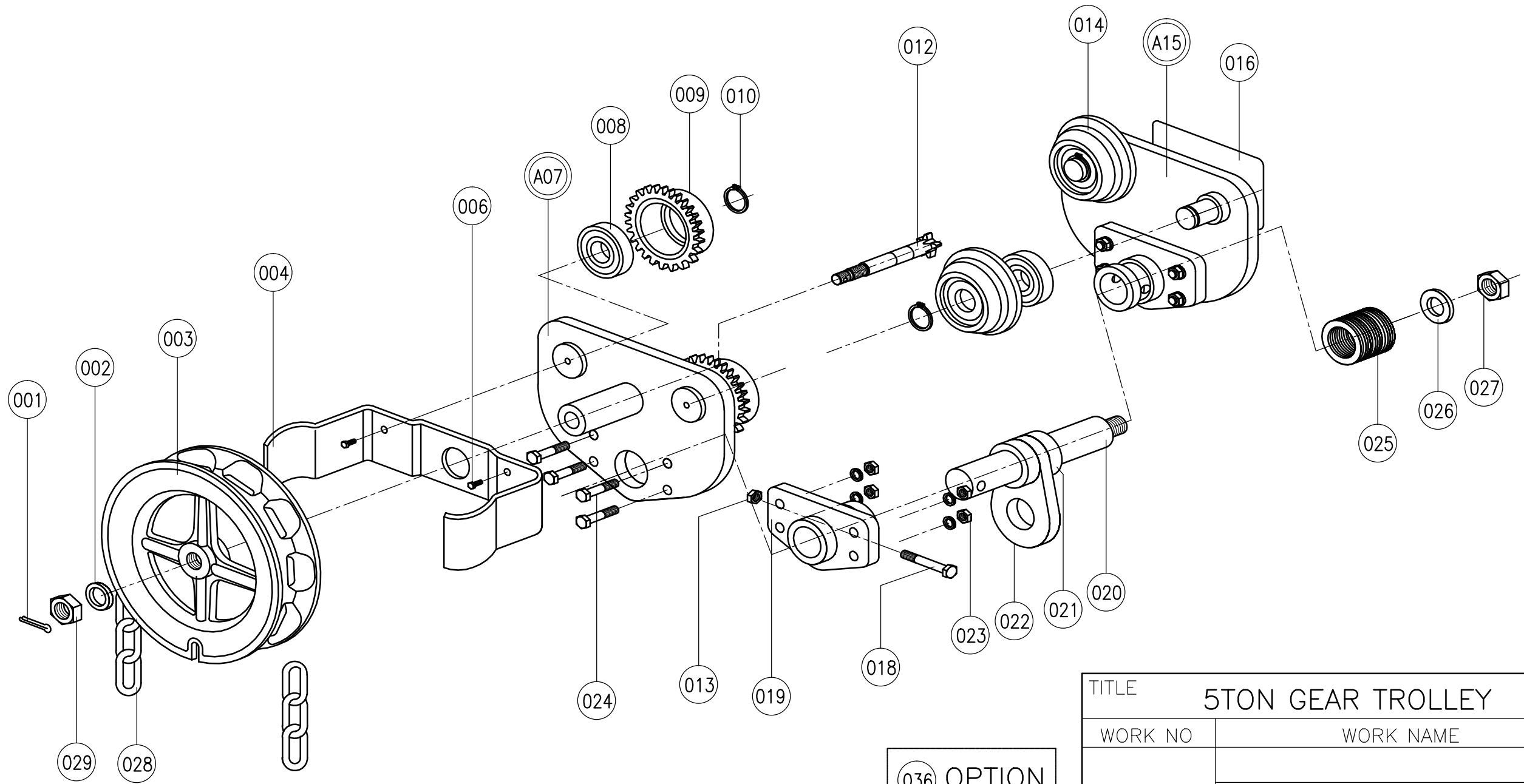

TITLE				5TON GEAR TROLLEY		PROJECTION	
WORK NO				WORK NAME			
						SCALE	Q'TY
						N S	1
DRAWN	CHECKED	REVIEWED	APPROVED	DRAWING NO			
J.D	-	LEE	Y. K	DSG050SE01			
2019.10.31	-	2019.10.31	2019.10.31				

REV.NO	DATE	REVISION DESCRIPTION	DRAWN	CHECKED	APPROVED

DAESAN INoTEC INC